

***DANYANG***

***TENYU***

***TOOLS***

Companyname





# COMPANY PROFILE

Manufacturing tools in drilling, chamfering, extracting★Live for Love★Focus on 19 years★

We have 20 CNC machines, 7 auto machines, and other kinds of 23 machines, and covering an area of 1300 square meter, and produce kinds of tools in drilling, chamfering, extracting. We will input more CNC machine to keep our products more precision, and keep all the user more enjoy wonderful life.

We will work diligently for every improvement, and if have your support, the world will become much more beautiful.

DANYANG TENYU TOOLS CO. , LTD

Melody

Manager

Email:manager@tenyutools.com

Fax:0086-511-86320970

Skype:melody7807

WhatsApp :008613952835481

Wechat:0086 13952835481

Web:www.tenyutools.com



TY-H01

HSS rolled forged with bight finished



TY-H02

HSS full ground TiN coated



TY-H03

HSS full ground TiN coated



TY-H04

HSS full ground with rainbow finished



TY-H05

HSS full ground Black & Golden



TY-H06

HSS full ground Cobalt



TY-H07

HSS full ground Cobalt with hex shank



TY-H08

HSS full ground with bright finished hex shank



TY-H09

HSS full ground TiN coated with hex shank





**TY-H10**

HSS taper shank with black surface



**TY-H11**

HSS taper shank with bright surface



**TY-H12**

HSS taper shank with black & bright surface



**TY-H19**

HSS straight flute step drill with bright surface



**TY-H20**

HSS step straight flute TiN coated with hex shank



**TY-H21**

HSS straight flute step drill with black surface



**TY-H13**

HSS redeced shank with bright surface



**TY-H14**

HSS cobalted redeced shank



**TY-H15**

HSS redeced shank with black & bright surface



**TY-H22**

HSS spiral flute step drill with black surface



**TY-H23**

HSS step spiral flute TiN coated with hex shank



**TY-H24**

HSS black step spiral flute with hex shank



**TY-H16**

HSS double flute with black surface



**TY-H17**

HSS short tin-coated



**TY-H18**

HSS extra long with bright surface

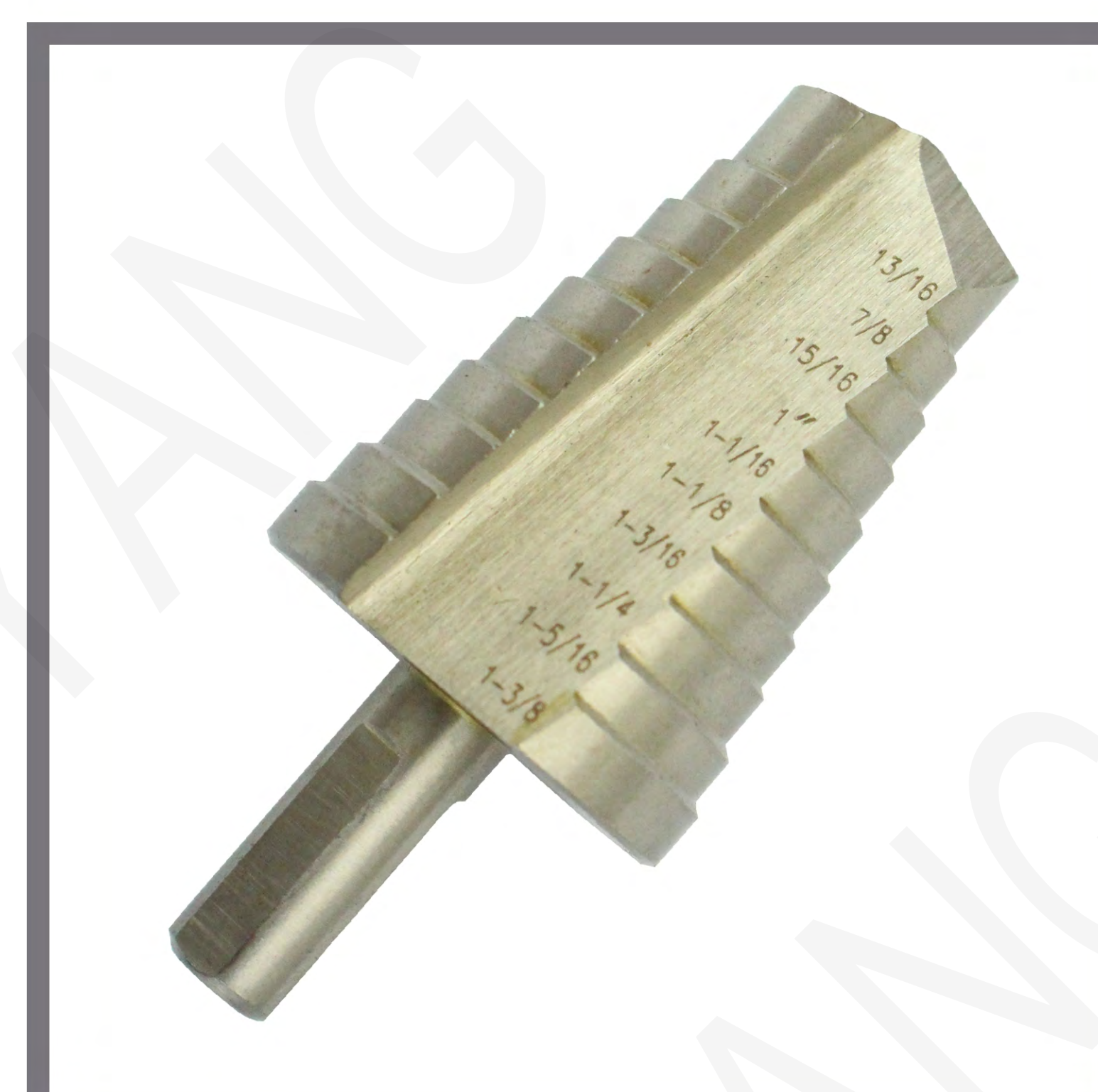

**TY-H25**

HSS step drill bright surface with triangular shank



**TY-H26**

HSS tube and sheet shell drills with triangular shank

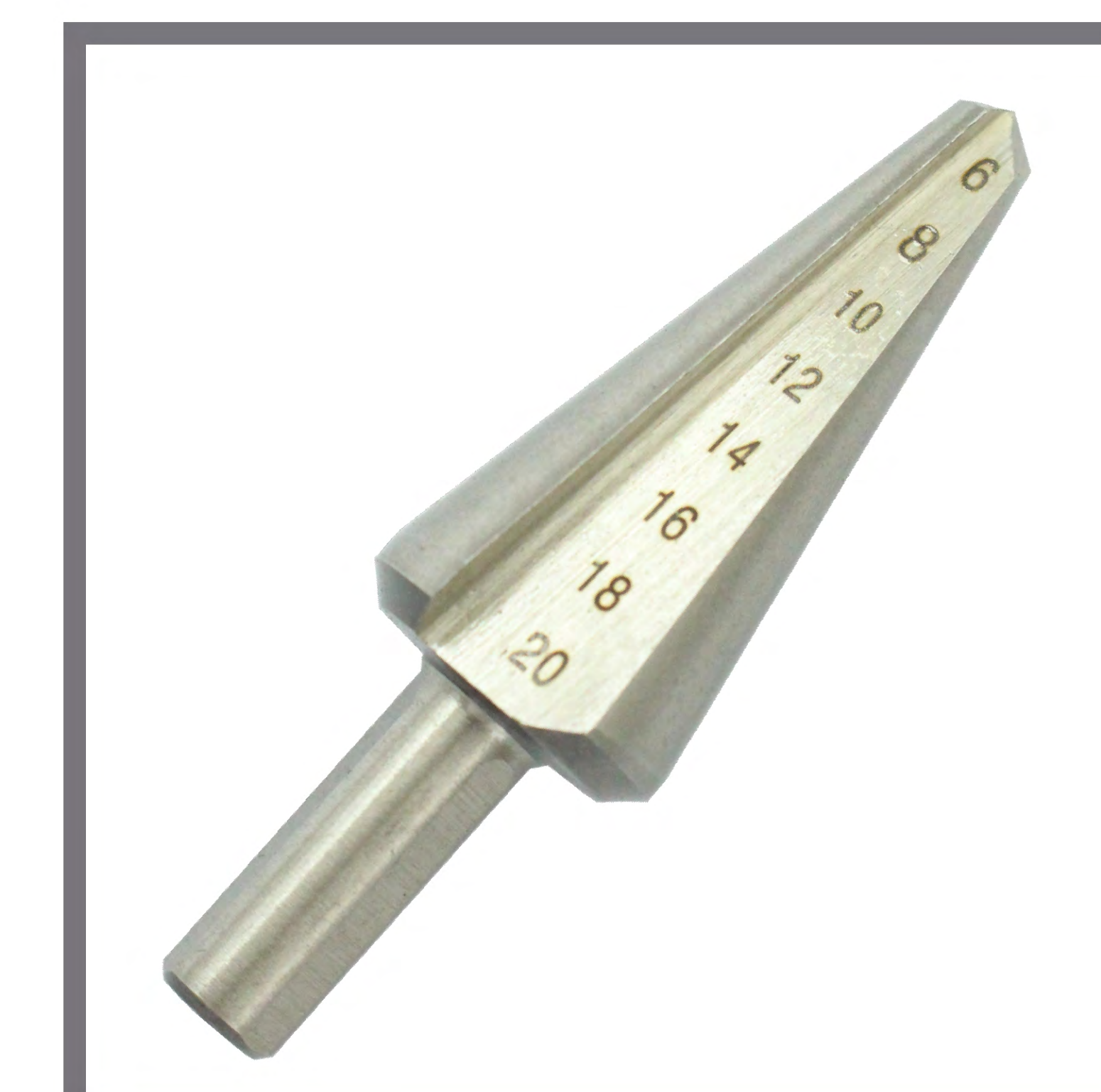

**TY-H27**

HSS tube and sheet shell drills





TY-H28

HSS center combined drill



TY-H29

HSS two step drill bits with hex shank



TY-H30

HSS pilot drill



TY-H37



TY-H38

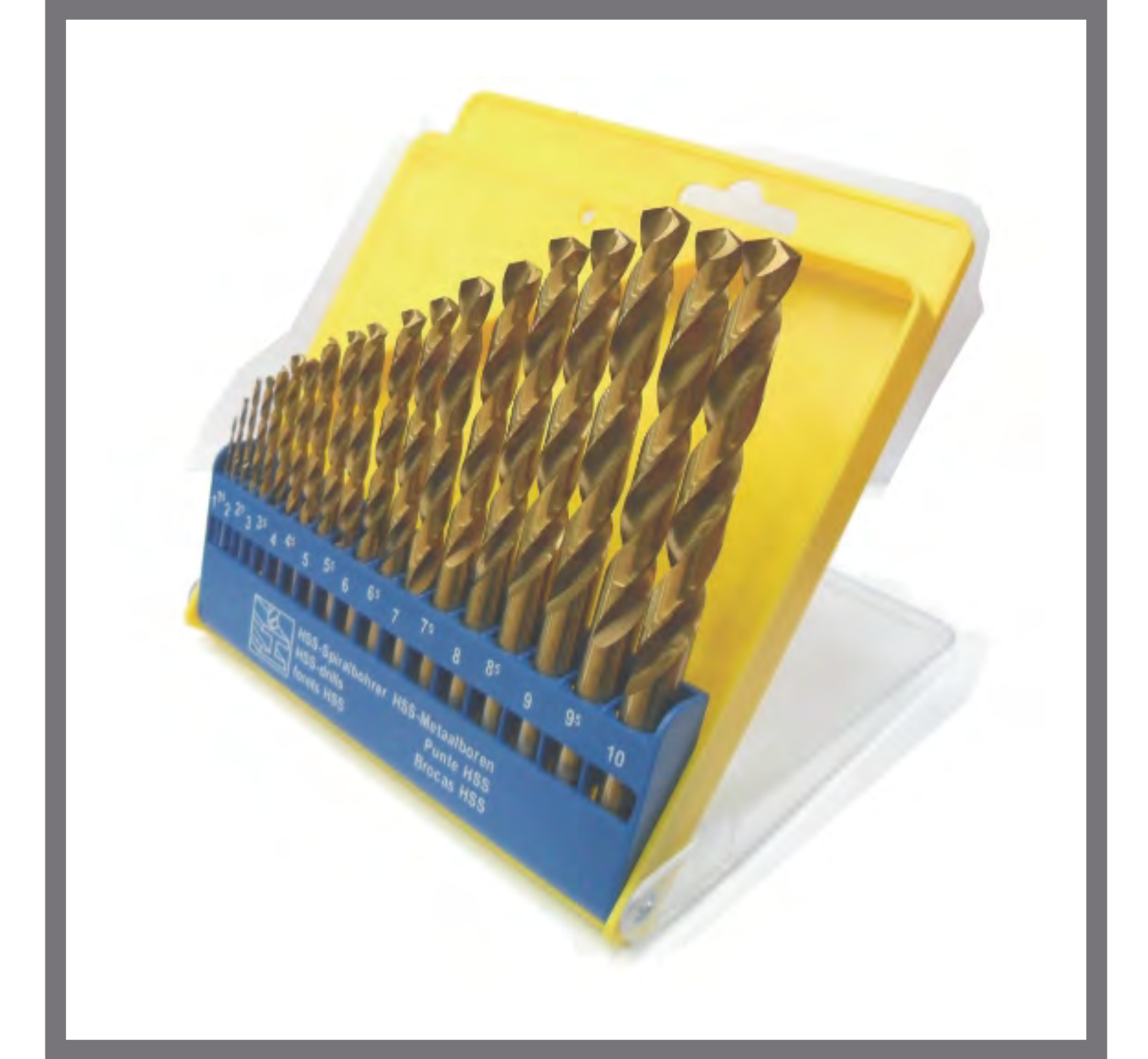

TY-H39



TY-H31



TY-H32



TY-H33



TY-H40



TY-H41



TY-H42



TY-H34



TY-H35



TY-H36

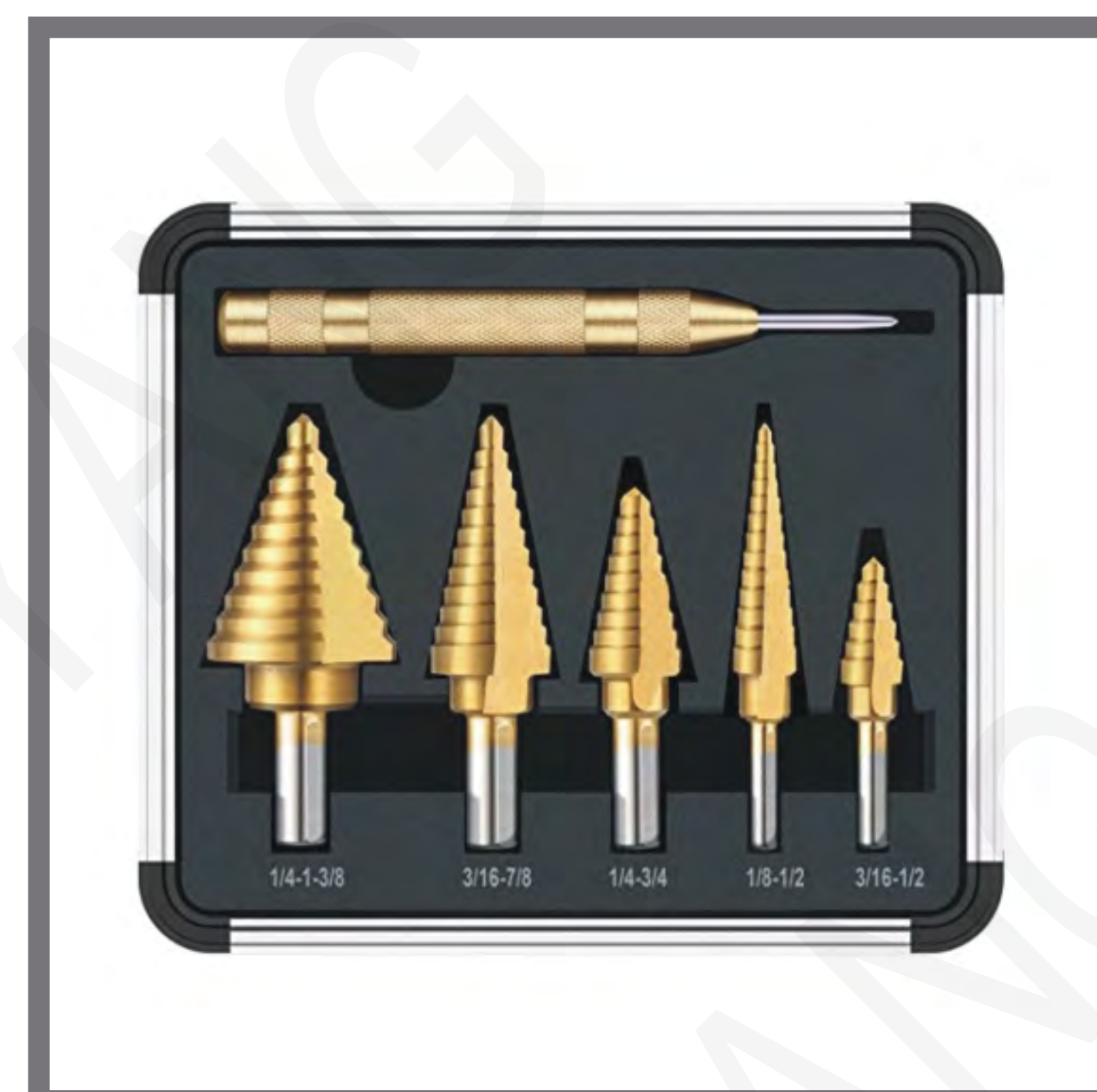

TY-H43



TY-H44



TY-H45





TY-G01



TY-G02



TY-G03



TY-M01



TY-M02



TY-M03



TY-G04



TY-G05



TY-G06



TY-M04



TY-M05



TY-M06



TY-G07



TY-G08



TY-G09



TY-M07

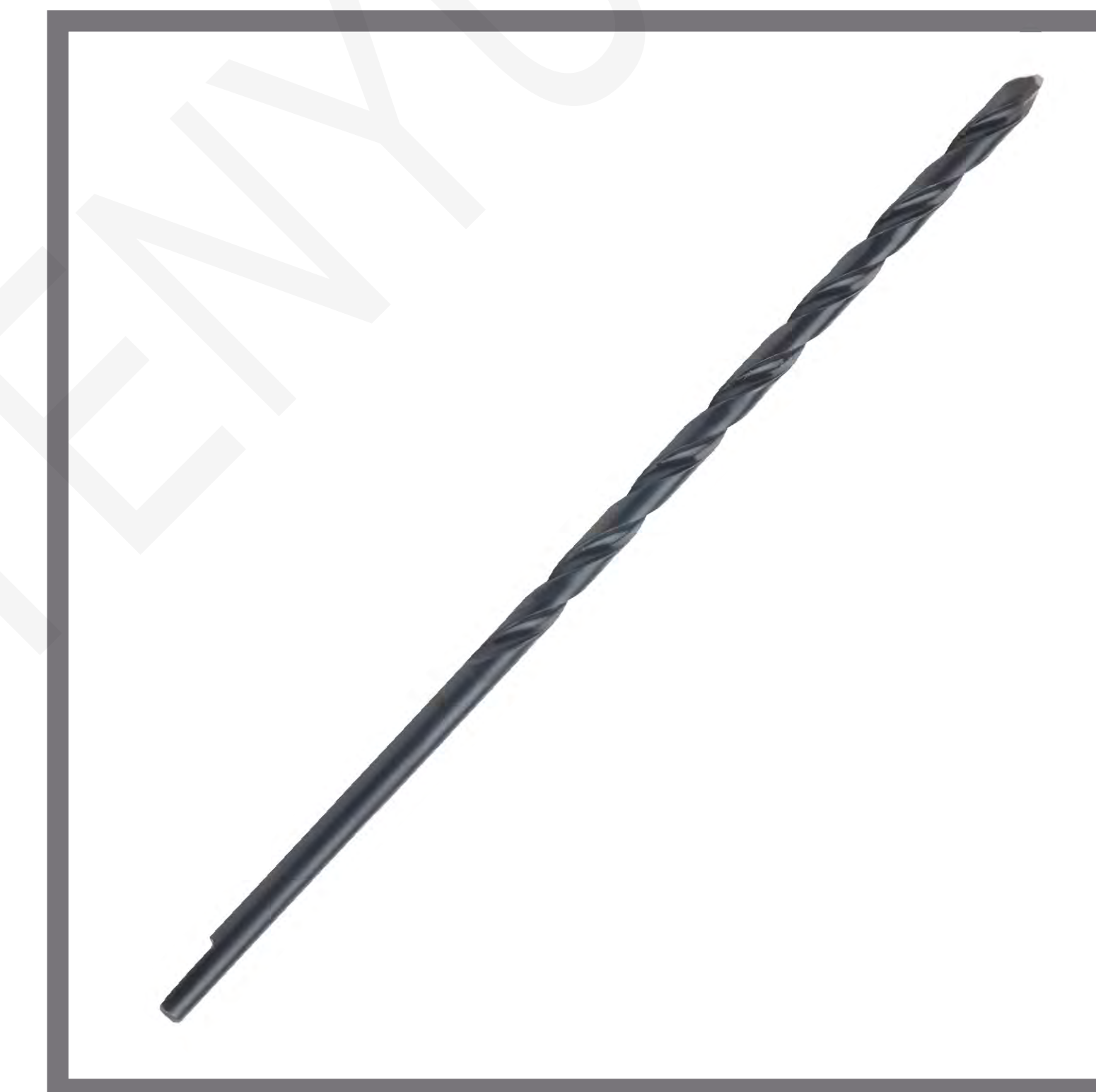

TY-M08



TY-M09





TY-S01



TY-S02



TY-S03



TY-C01



TY-C02



TY-C03



TY-S04



TY-S05



TY-S06



TY-C04

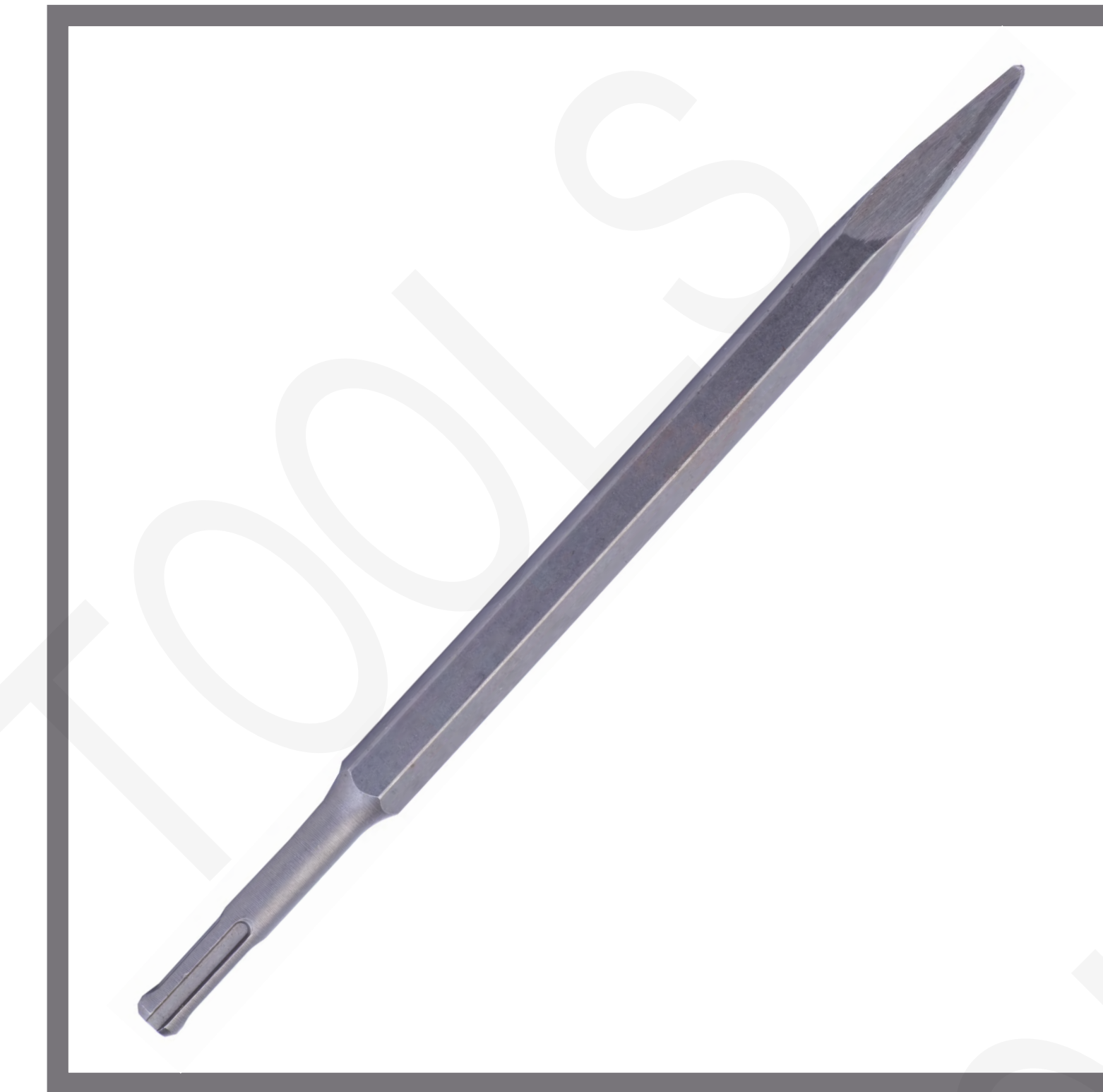

TY-C05



TY-C06



TY-S07



TY-S08



TY-S09



TY-C07



TY-C08



TY-C09





TY-C10



TY-C11



TY-C12



TY-S10



TY-S11



TY-S12



TY-C13



TY-C14



TY-C15



TY-S13



TY-S14



TY-S15



TY-C16



TY-C17



TY-C18



TY-S16



TY-S17



TY-S18





TY-W01



TY-W02



TY-W03



TY-W04



TY-W13



TY-W14



TY-W05



TY-W06



TY-W07



TY-W08

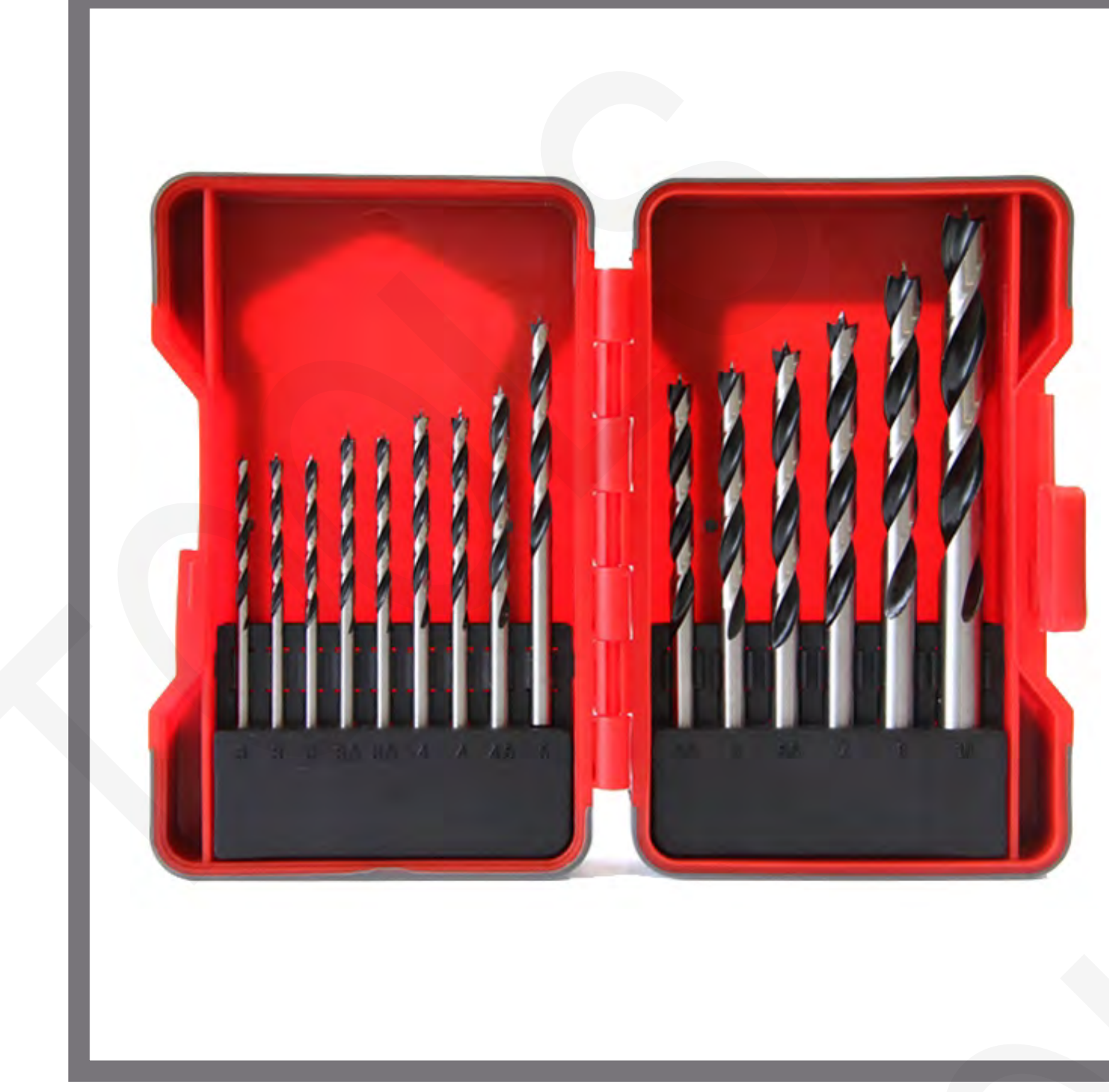

TY-W15



TY-W16



TY-W09



TY-W10



TY-W11



TY-W12



TY-W16



TY-W17





TY-G10



TY-G11



TY-G12



TY-D01



TY-D02



TY-D03



TY-G13



TY-G14



TY-M10



TY-D04



TY-D05



TY-D06



TY-M11



TY-M12



TY-M13



TY-D07



TY-D08



TY-D09





TY-TCT01

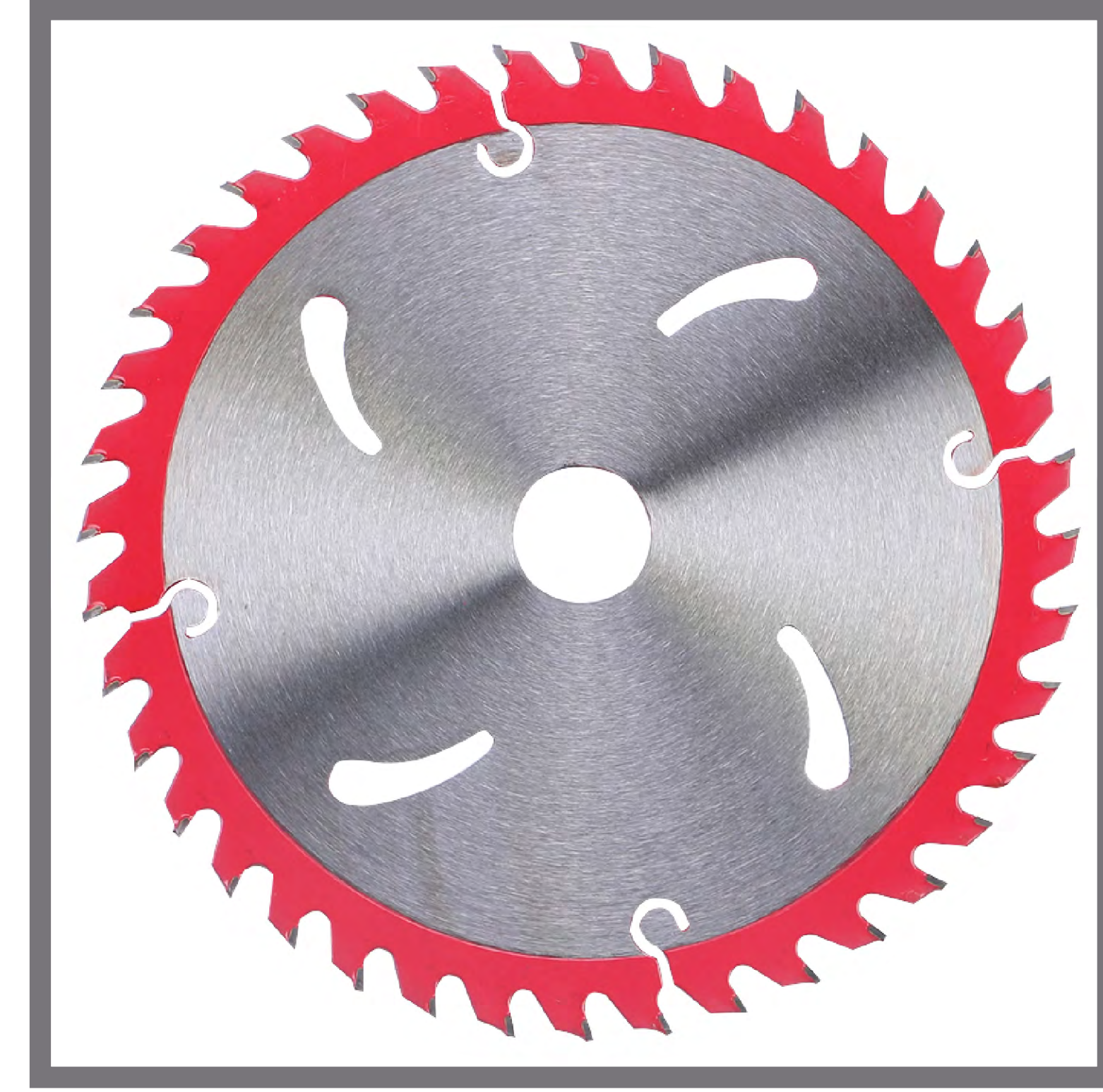

TY-TCT02



TY-TCT03



TY-TCT04



TY-TCT05

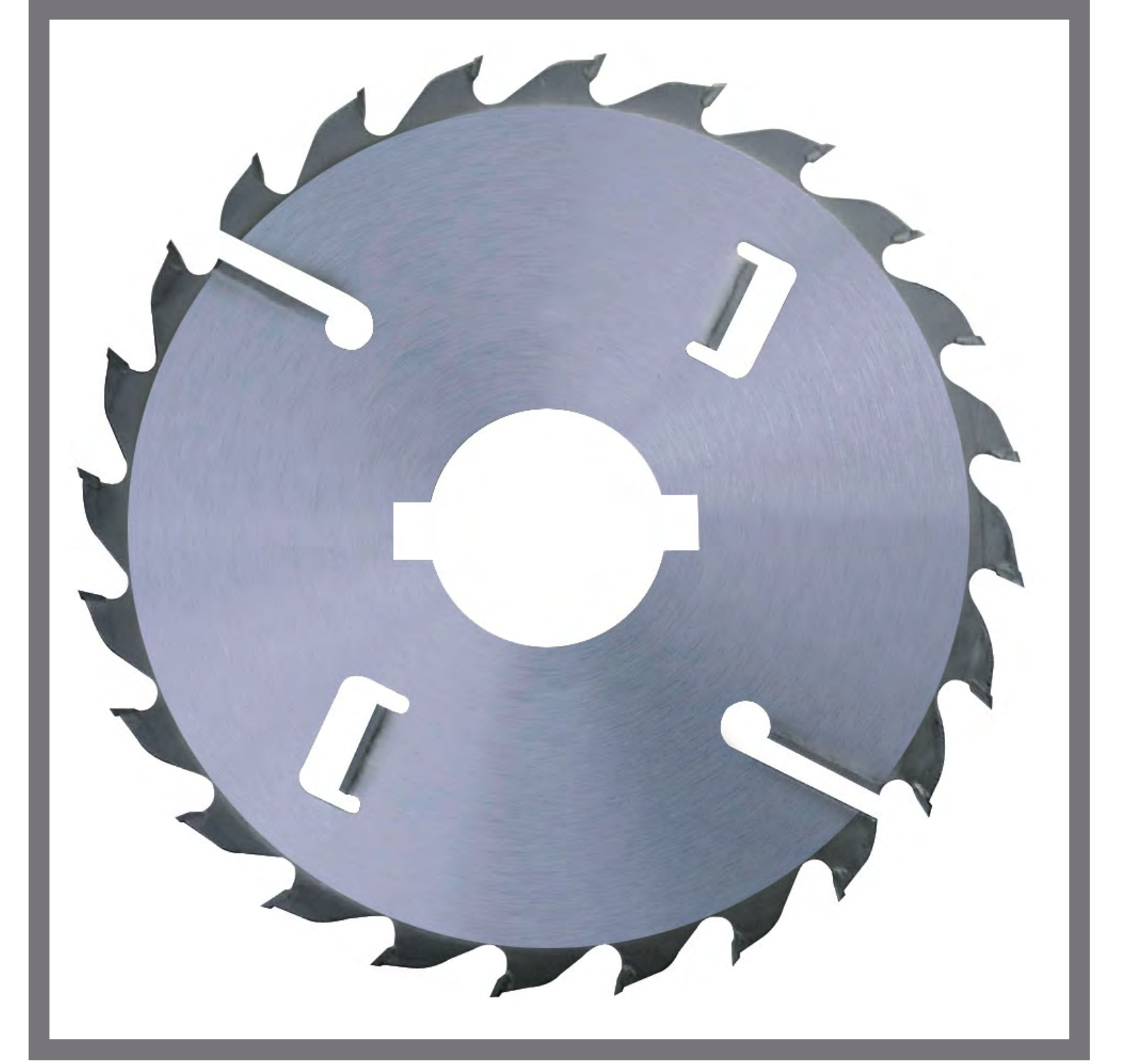

TY-TCT06



TY-TCT07



TY-TCT08



TY-TCT09



TY-TCT10

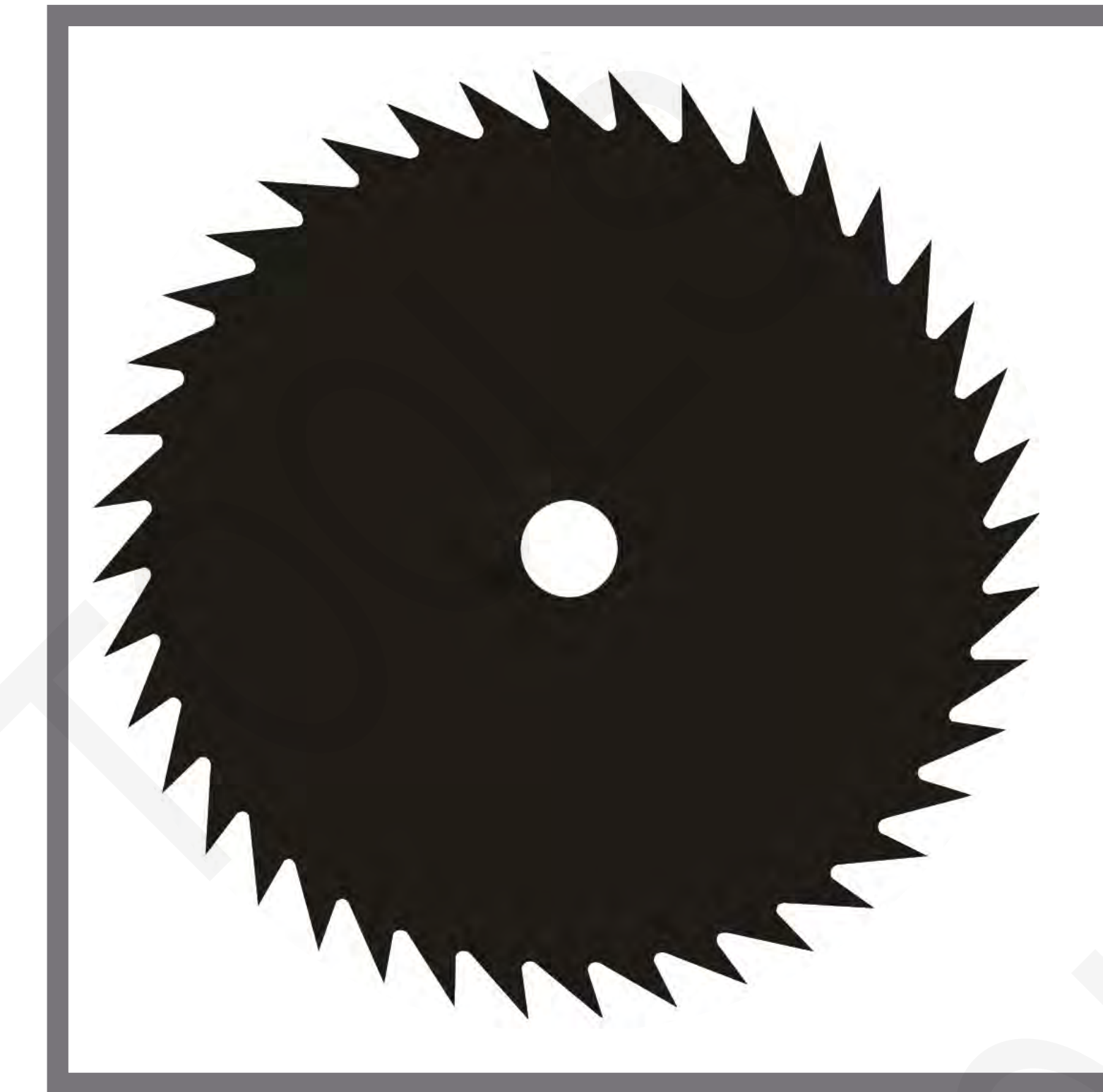

TY-TCT11



TY-TCT12

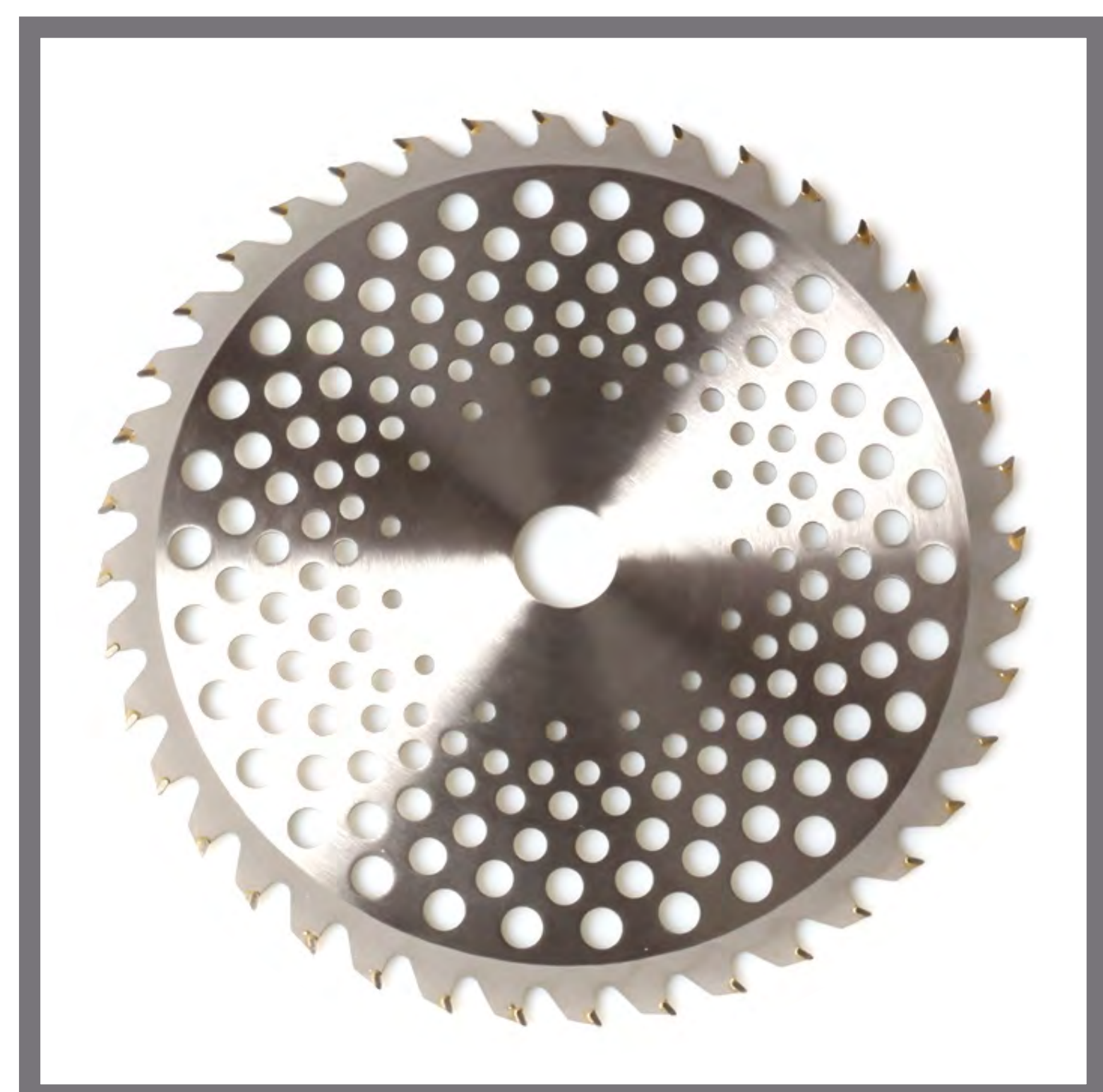

TY-TCT13

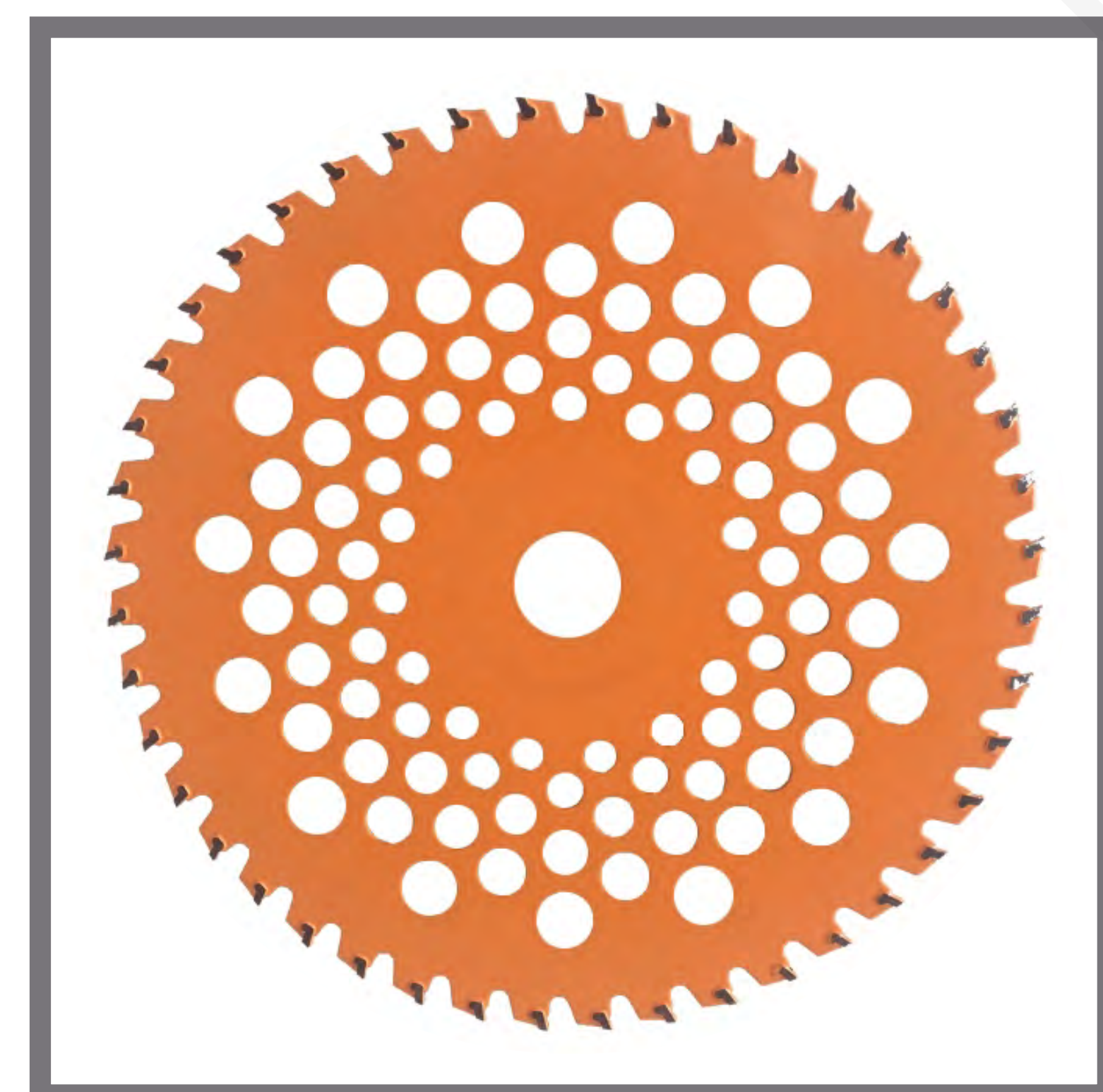

TY-TCT14

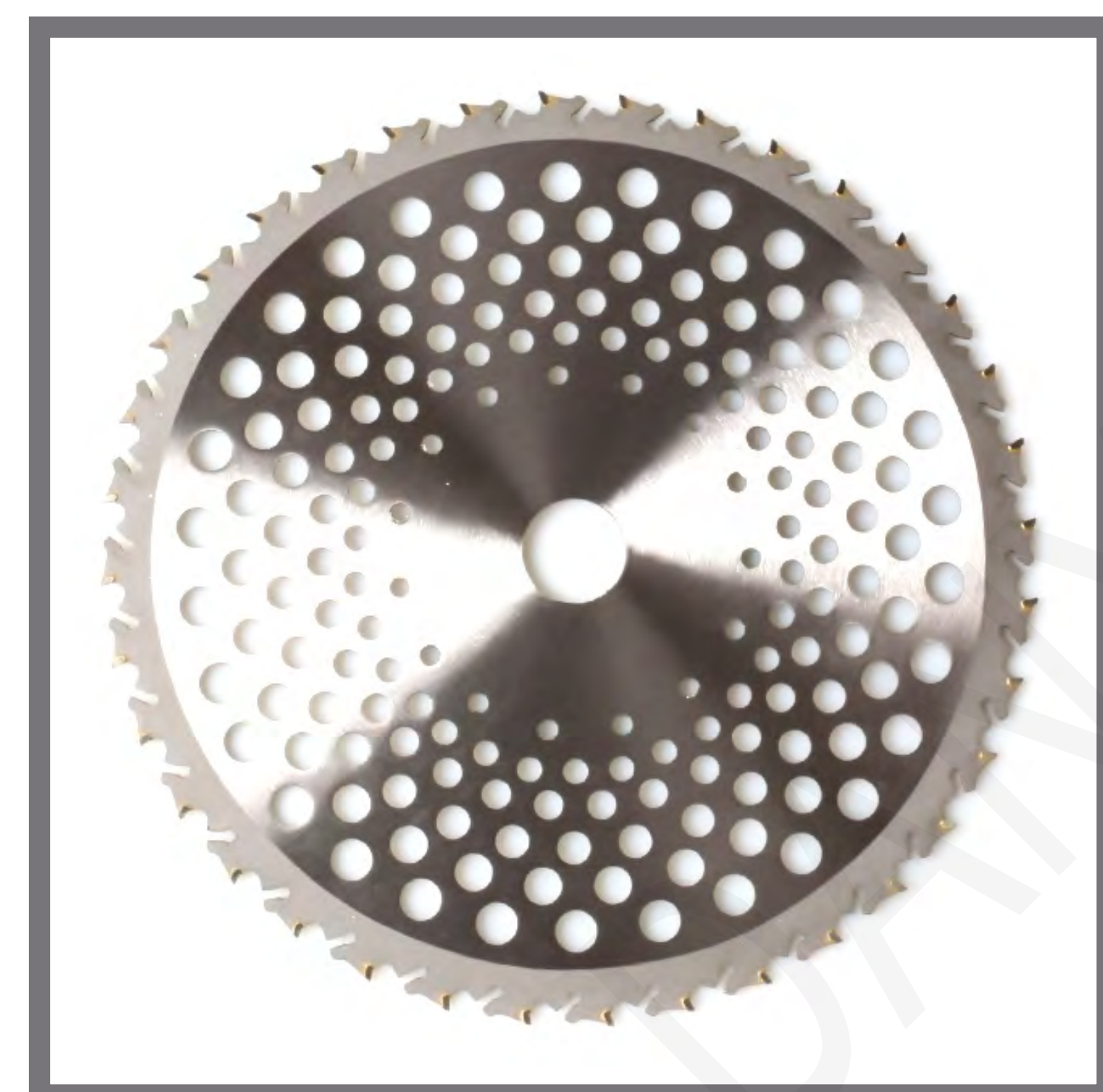

TY-TCT15



TY-TCT16



TY-TCT17



TY-TCT18





TY-DA01

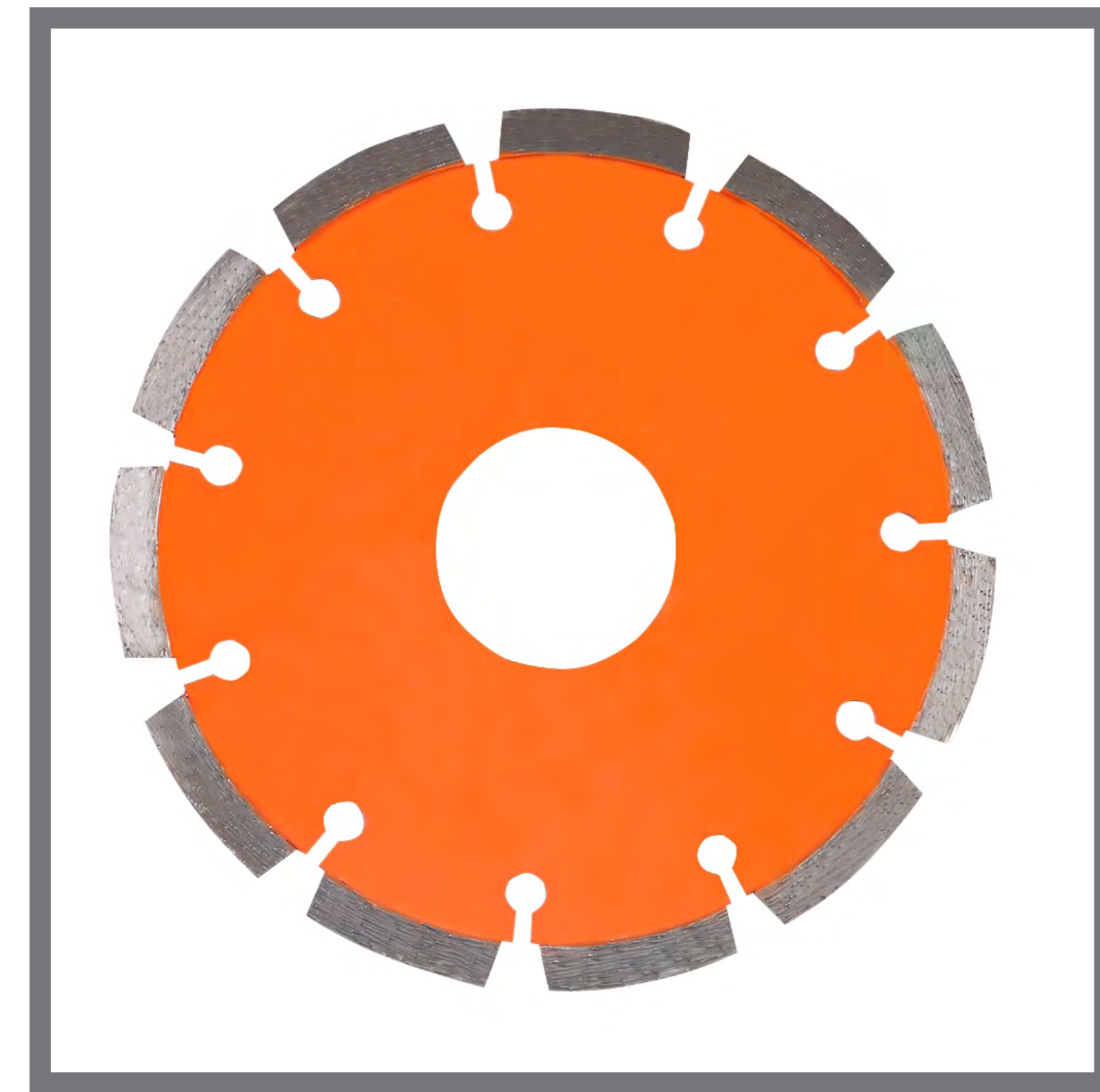

TY-DA02

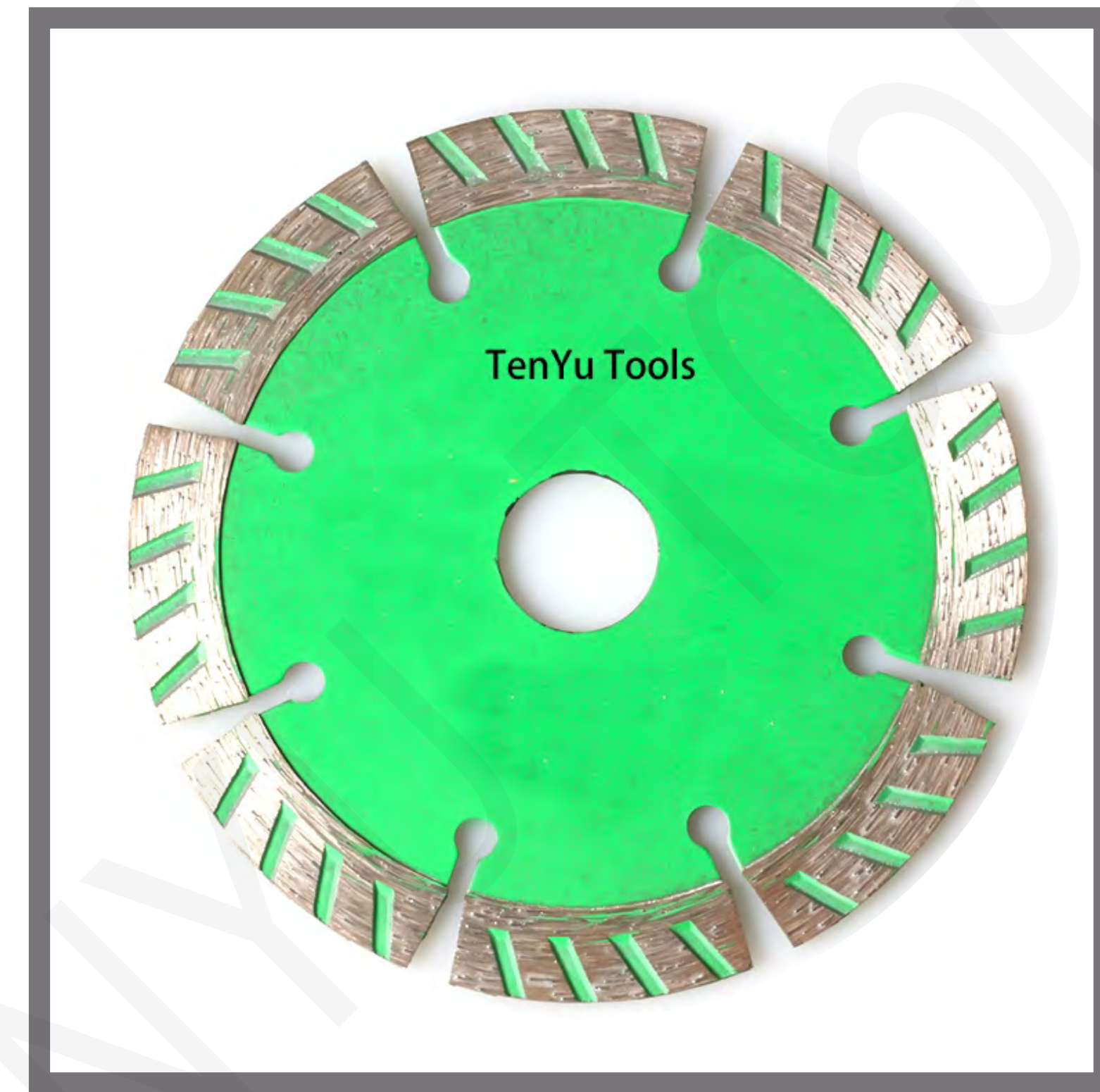

TY-DA03

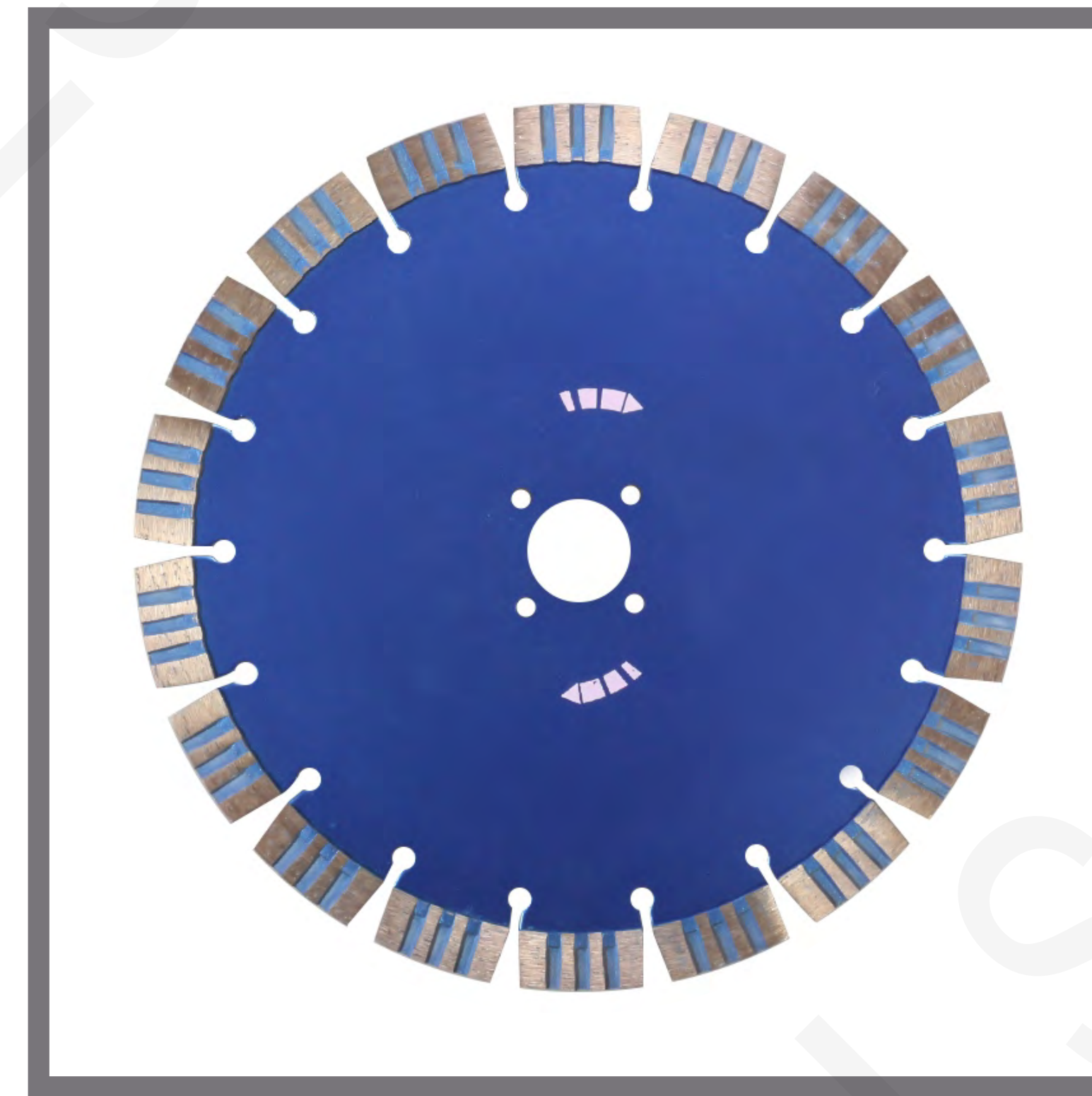

TY-DA04



TY-DA05



TY-DA06



TY-DA07

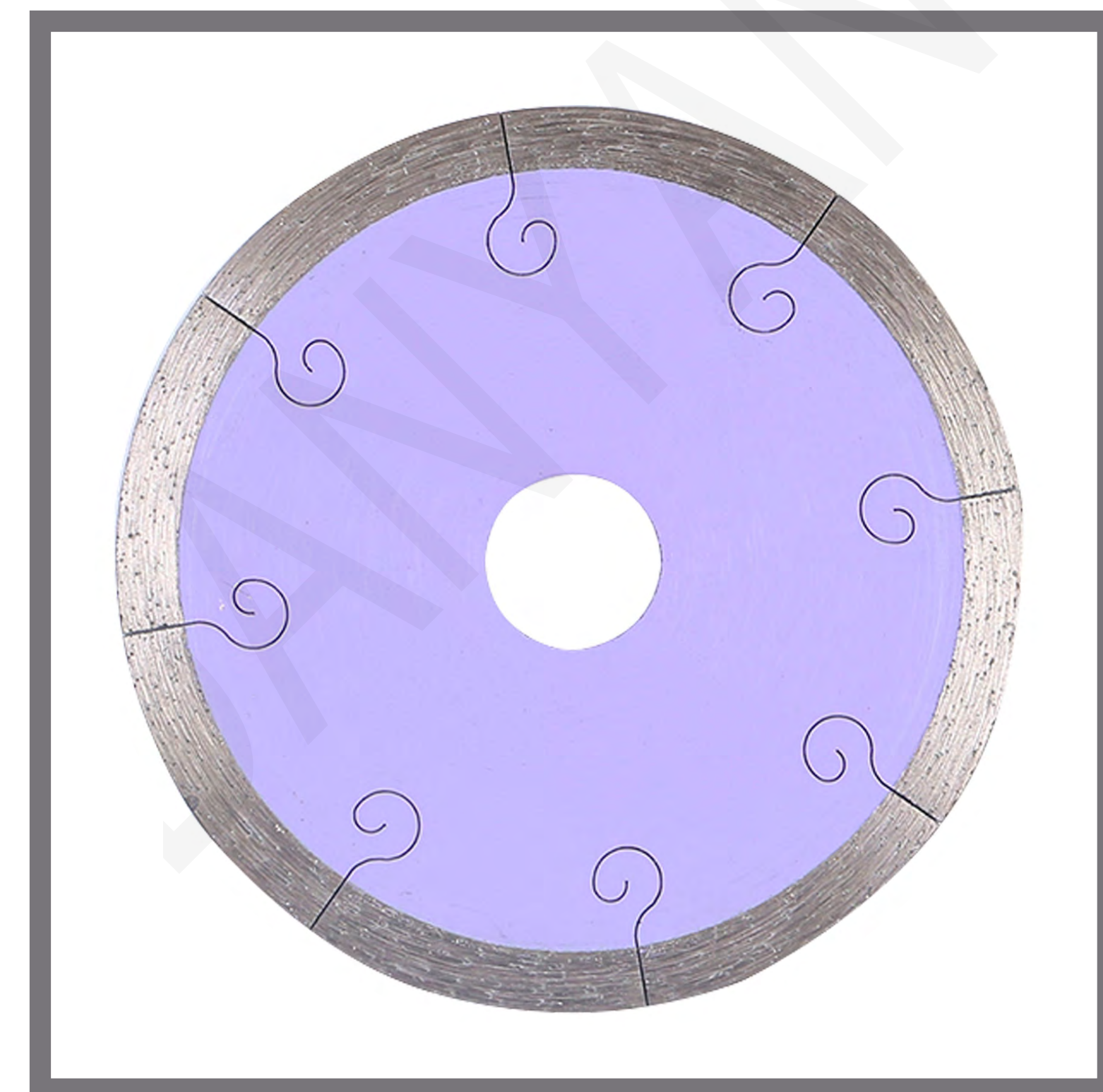

TY-DA08

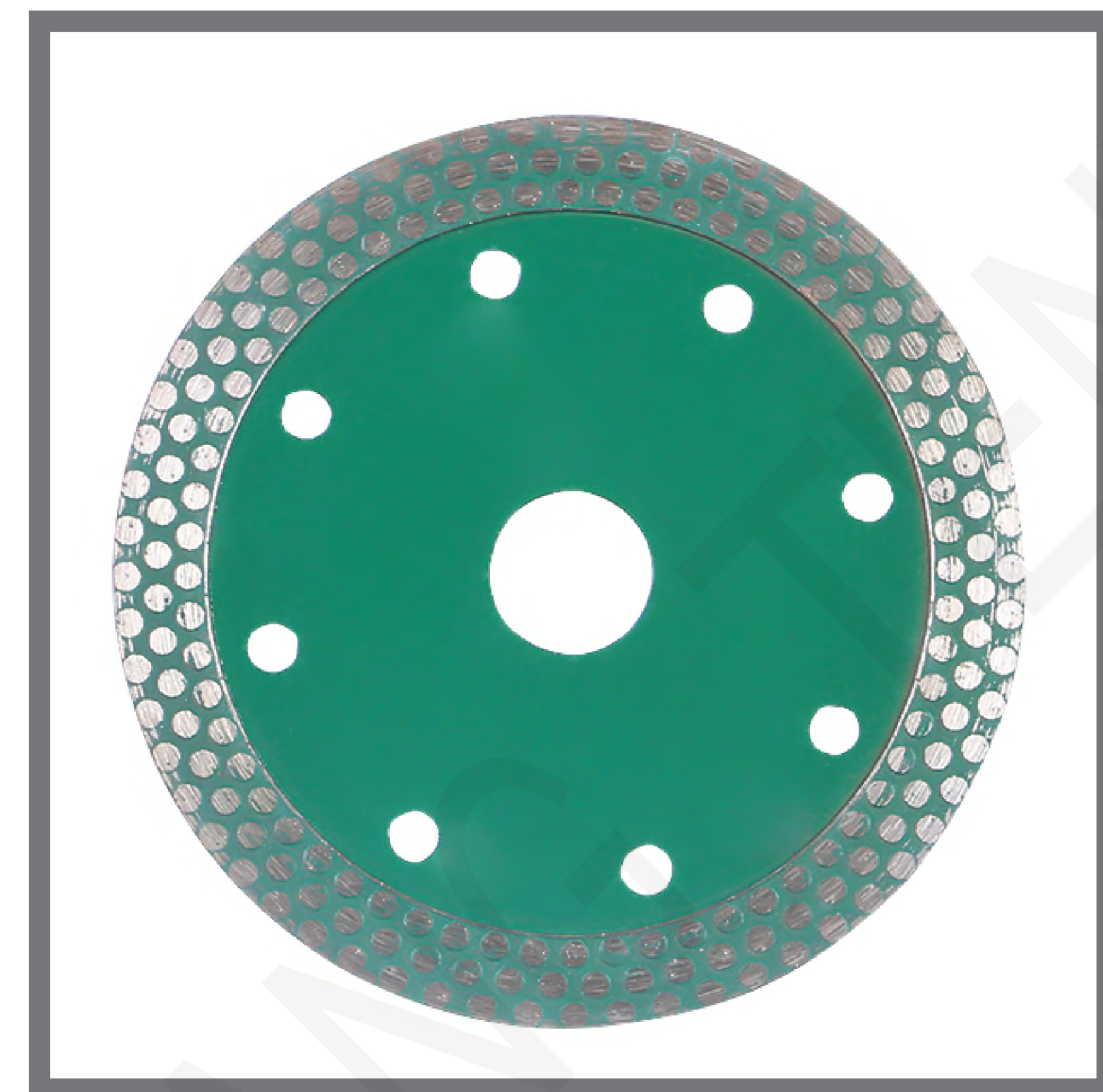

TY-DA09

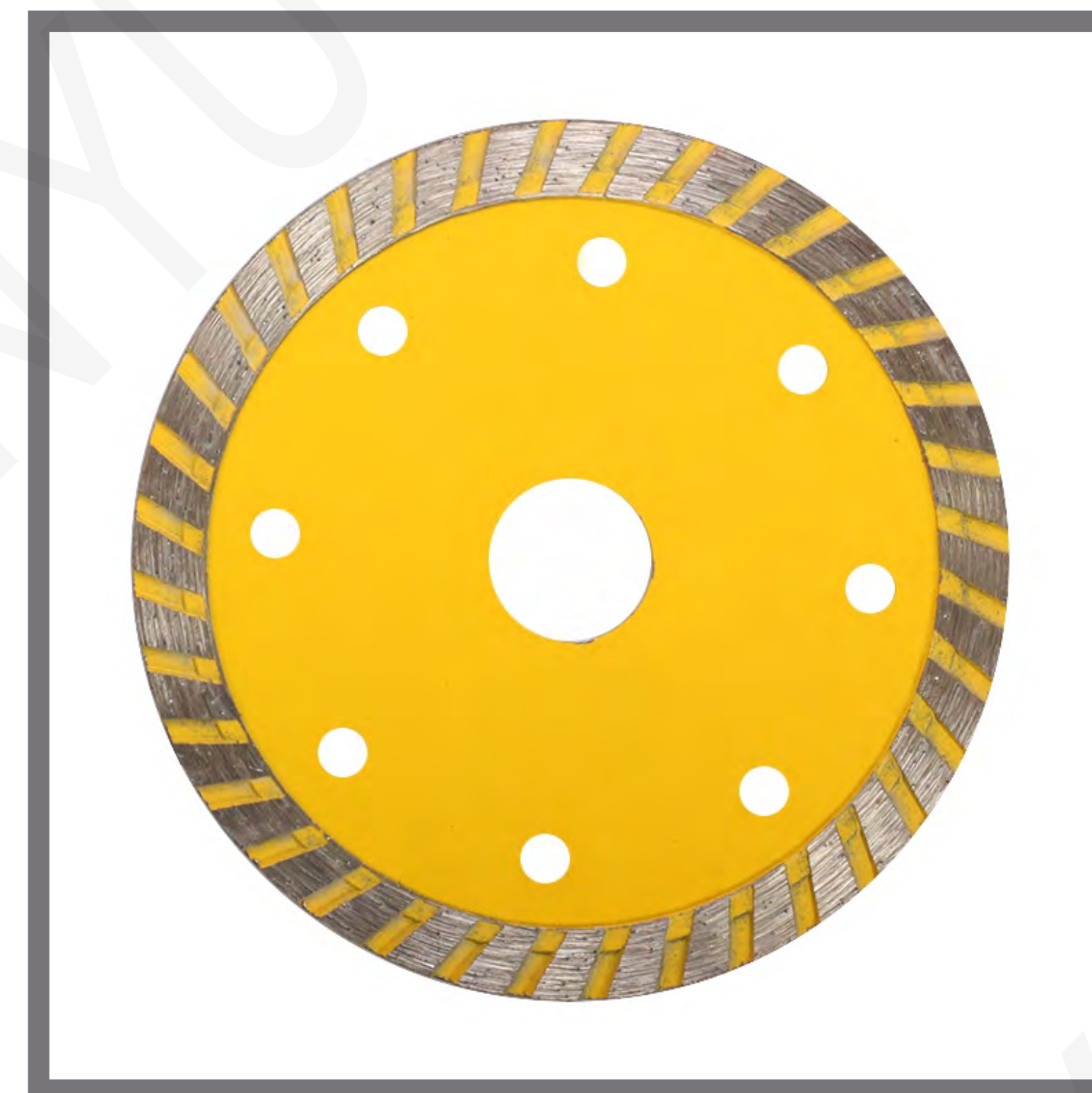

TY-DA10

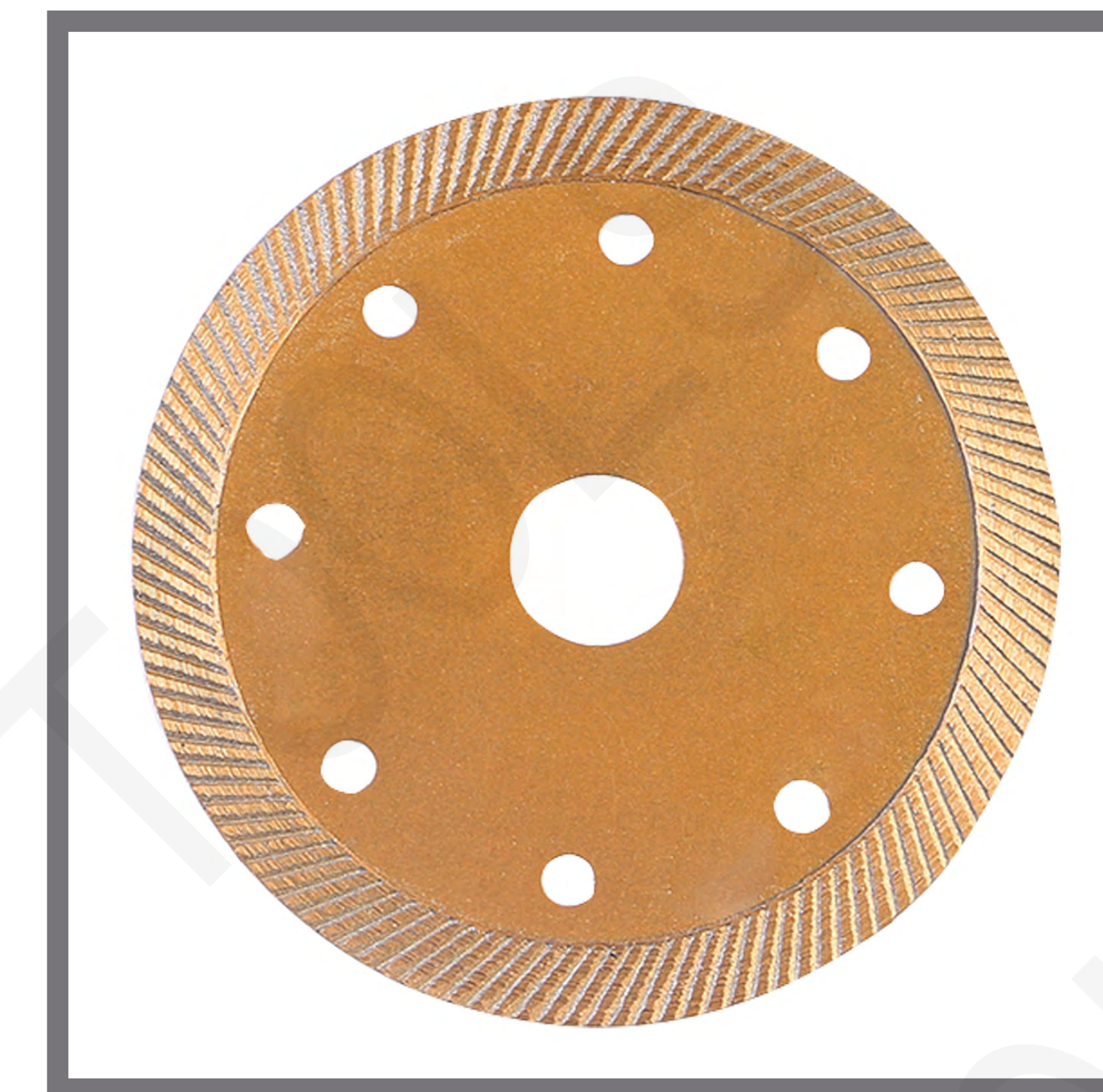

TY-DA11



TY-DA12



TY-DA13



TY-DA14



TY-DA15

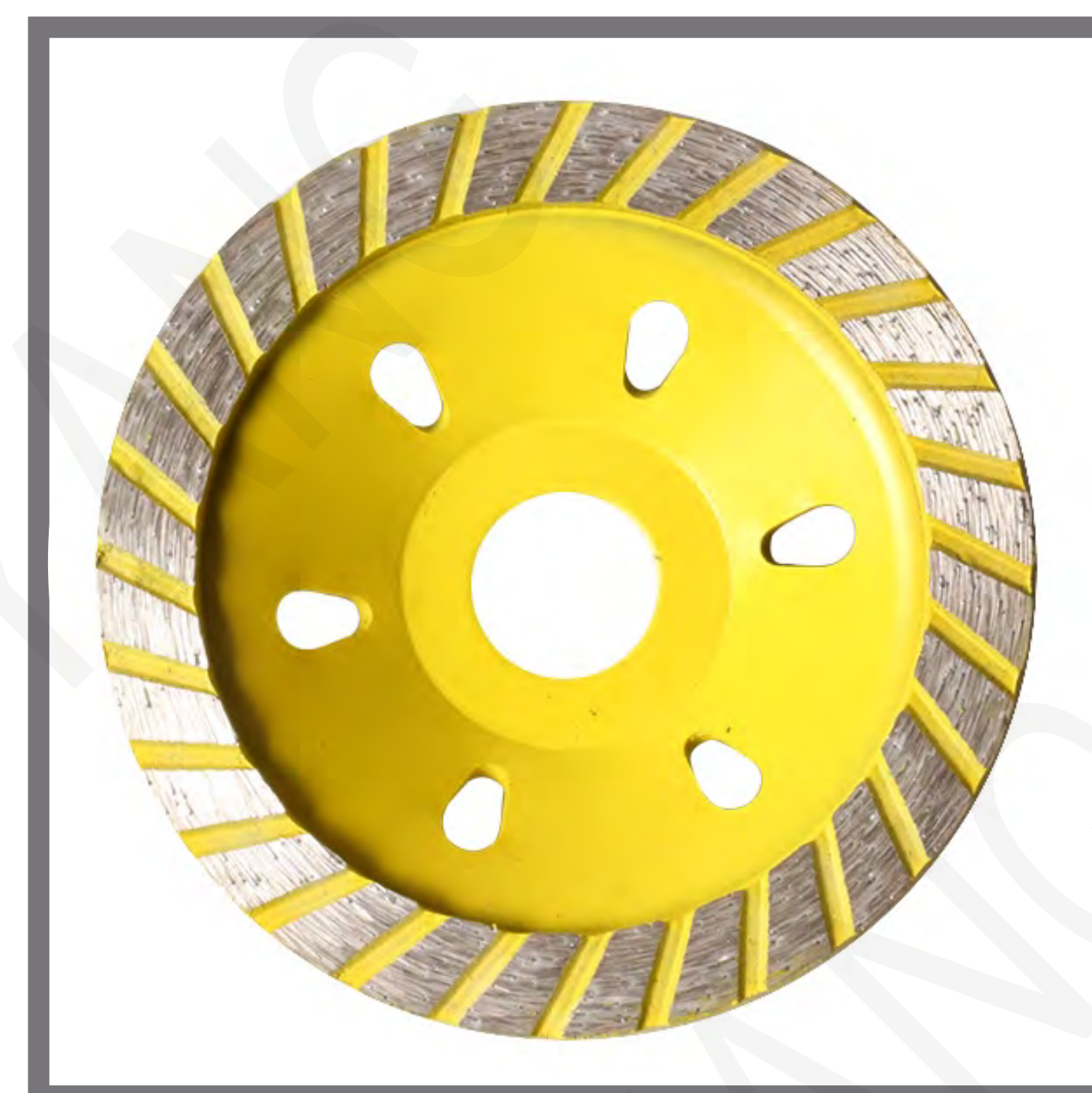

TY-DA16

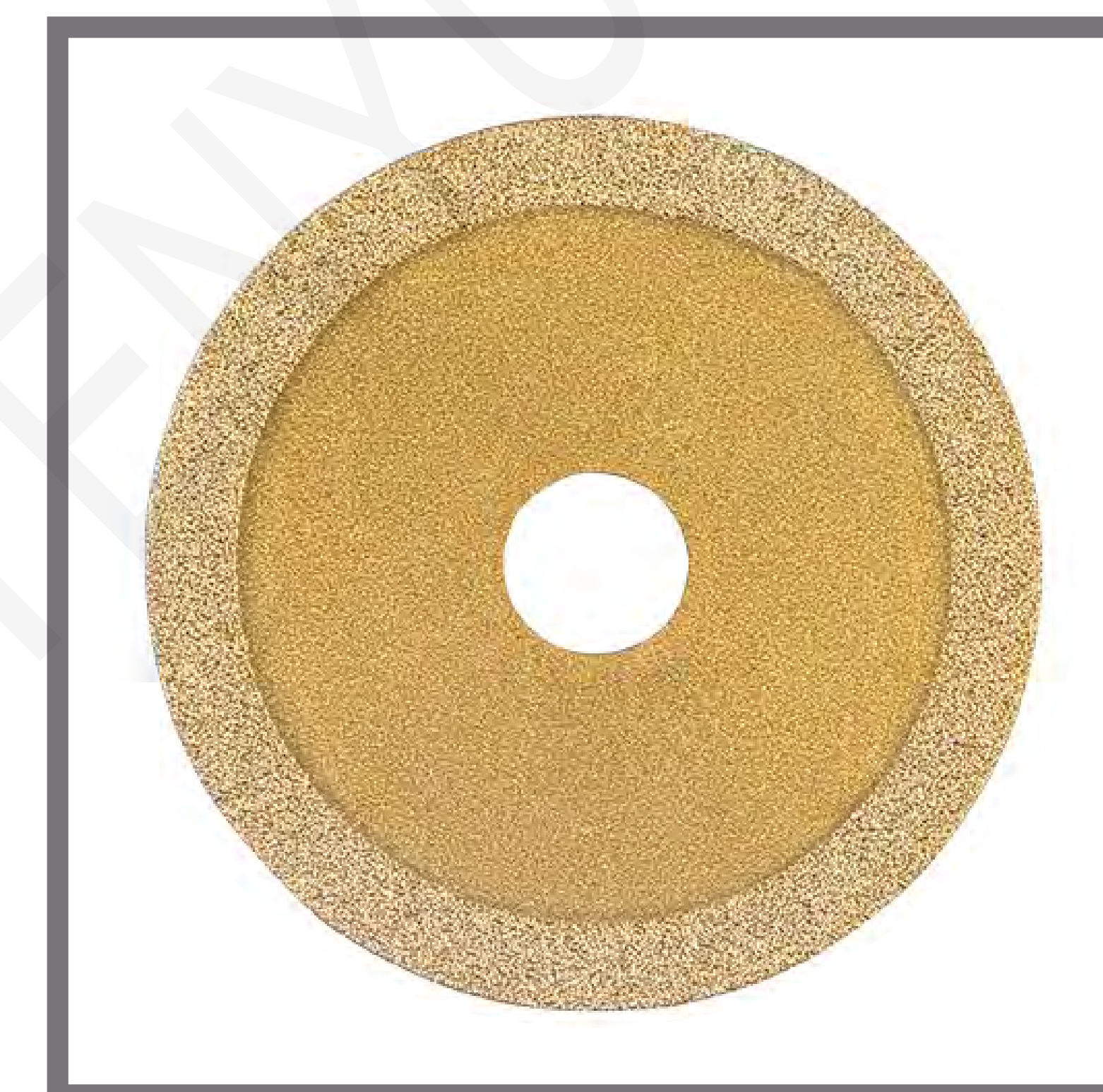

TY-DA17



TY-DA18





TY-A01

Automatic center punch



TY-A02

90° angle hex shank extension



TY-A03

Quick change hinge drill



TY-A04

Electronic Right Angle



TY-A05

Electric Drill Scissors



TY-A06

Hand deburring blades



TY-A07

Garden grafting pruning pruner scissors



TY-A08

Multipurpose double head sheet metal nibbler cutter tool



TY-A09

90 degree Screwdriver Socket Holder Adaptor



TY-A10

Screwdriver



TY-A11

5pcs rotary files & 5 pcs hss rotary burrs



TY-A12

5pcs rotary files & 5pcs rotary rasp



TY-A13

tap bit set



TY-A14

Quick change countersink single flute & hss drill



TY-A15

Countersink single flute & wood working drill



TY-A16

Punch



TY-A17

Saw drill



TY-A18

Plug cutter